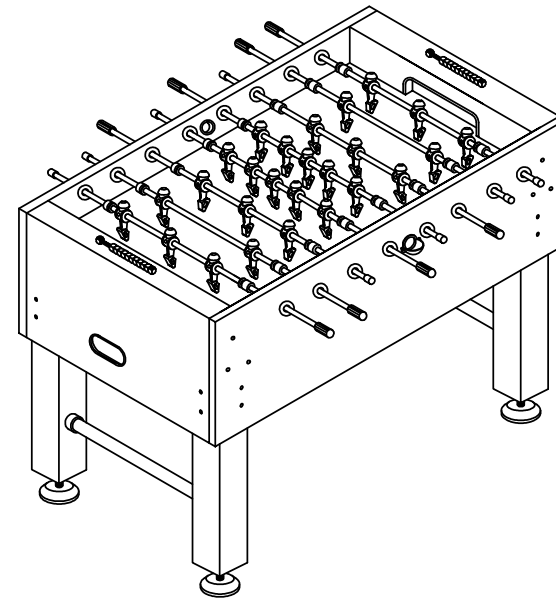

TABLE SOCCER

ASSEMBLY INSTRUCTIONS



ASSEMBLY INSTRUCTIONS

SOCCER TABLE ASSEMBLY

WARNING: TWO ADULTS NEEDED TO ASSEMBLE SOCCER TABLE

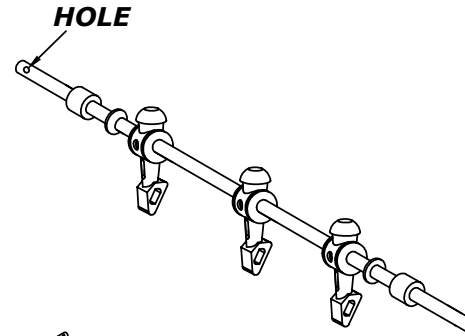

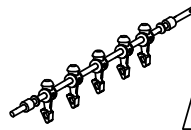
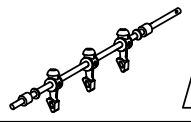
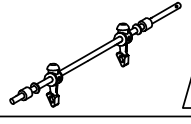
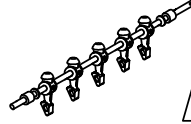
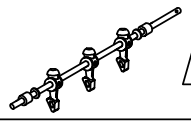
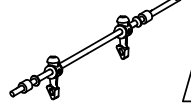
| | | <i>QTY</i> |
|---|------------------------------|------------|
|  | R1 5 HOME PLAYERS ROD | 1 |
|  | R2 3 HOME PLAYERS ROD | 2 |
|  | R3 2 HOME PLAYERS ROD | 1 |
|  | R4 5 AWAY PLAYERS ROD | 1 |
|  | R5 3 AWAY PLAYERS ROD | 2 |
|  | R6 2 AWAY PLAYERS ROD | 1 |

ASSEMBLY INSTRUCTIONS

SOCCER TABLE ASSEMBLY

WARNING: TWO ADULTS NEEDED TO ASSEMBLE SOCCER TABLE

- INSERT THE PLAYER RODS **C1&C2&C3** THROUGH ONR SIDE PANEL, THEN INSERT PLAYERS **C8&C9** AND RUBBER BUSHINGS **C4**, PLASTIC WASHERS **C5** THROUGH THE ROD, REFER TO **R1~R6**. THEN INSERT THE PLAYER ROD THROUGH OTHER SIDE PANEL, ATTACH THE PLAYERS **C8&C9** WITH BOLTS **C6** AND NUTS **C7**. SEE **Figure 5**.
- SLIDE THE HANDLES **P7** ONTO THE ENDS OF THE RODS WITH BOLT **H9**. SLIDE THE RUBBER CAPS **P8** ON THE OTHER END OF THE ROD .

Tighten all the hardware before playing games !

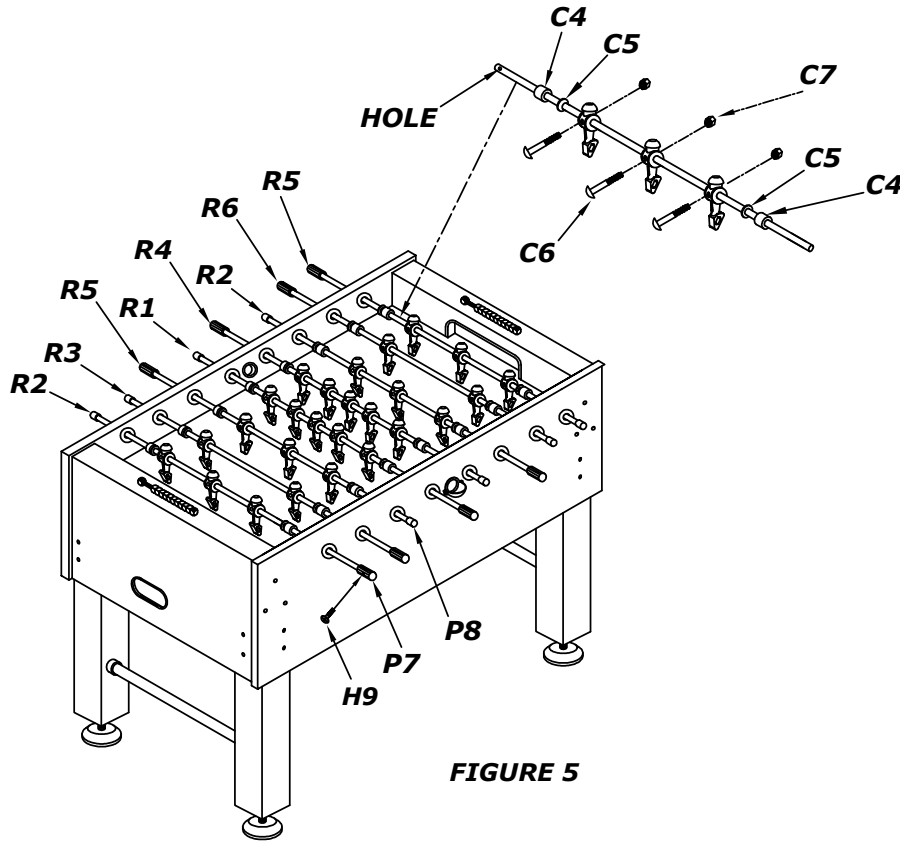

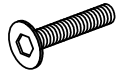



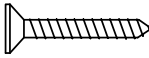
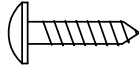
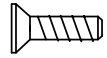
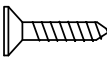



FIGURE 5

PARTS IDENTIFIER

HARDWARE











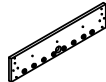



| | | DESCRIPTION | QTY. REQUIRED <small>(EXTRA PIECES MAY BE INCLUDED)</small> |
|---|-----------|---------------------------------|--|
|  | H1 | M8x45 BOLT | 16 |
|  | H2 | M8x20 BOLT | 4 |
|  | H3 | M8 WASHER, BLACK FLAT | 20 |
|  | H4 | M6 LOCK HEX NUT | 18 |
|  | H5 | M6 WASHER, BLACK FLAT | 18 |
|  | H6 | M5x6 BOLT | 4 |
|  | H7 | 1-1/2" FLAT HEAD PHILLIPS SCREW | 4 |
|  | H8 | 5/8" ROUND HEAD PHILLIPS SCREW | 2 |
|  | H9 | BOLT (use to screw the handle) | 8 |
|  | S1 | 5/8" FLAT HEAD PHILLIPS SCREW | 24 |

ACCESSORIES

| | | DESCRIPTION | QTY |
|---|-----------|-------------|-----|
|  | A1 | SOCCER BALL | 4 |
|  | A2 | TOOL | 4 |

PARTS IDENTIFIER

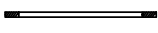
ASSEMBLY PARTS

| | DESCRIPTION | QTY |
|---|-----------------------------------|-----|
|  | P1 SIDE PANEL | 2 |
|  | P2 END PANEL | 2 |
|  | P3 PLAYING FIELD | 1 |
|  | P4A LEG A | 2 |
|  | P4B LEG B | 2 |
|  | P5 PLAYFIELD SUPPORT BRACE | 3 |
|  | P6 SLIDE SCORER | 2 |
|  | P7 HANDLE | 8 |
|  | P8 ROD END CAP | 8 |
|  | P9A BALL ENTRY CUP | 2 |
|  | P9B BALL ENTRY SOCKET | 2 |
|  | P10 LEG LEVELER | 4 |
|  | P11 LONG BOLT | 9 |
|  | P12 FIXED IRON | 4 |
|  | P13 CROSS BAR | 2 |

ASSEMBLY INSTRUCTIONS

SOCCER TABLE ASSEMBLY

WARNING: TWO ADULTS NEEDED TO ASSEMBLE SOCCER TABLE

- ATTACH BALL ENTRY CUPS **P9A** AND **P9B** TO THE SIDE PANELS WITH SCREWS **H8** AS SHOWN IN **figure 4**. ATTACH THE TWO SETS OF SLIDE SCORER **P6** TO THE END OF TABLE WITH PHILLIS HEAD SCREWS **H7**. ATTACH THE ROD BUSHING **C10A&C10B** TO THE SIDE PANELS AS SHOWN IN **FIGURE 4**.
- ATTACH THE PLASTIC **#2a, #2b, #3a, #3b**, TO THE PLAYING FIELD WITH **S1** AS SHOWN IN **Figure 4**.

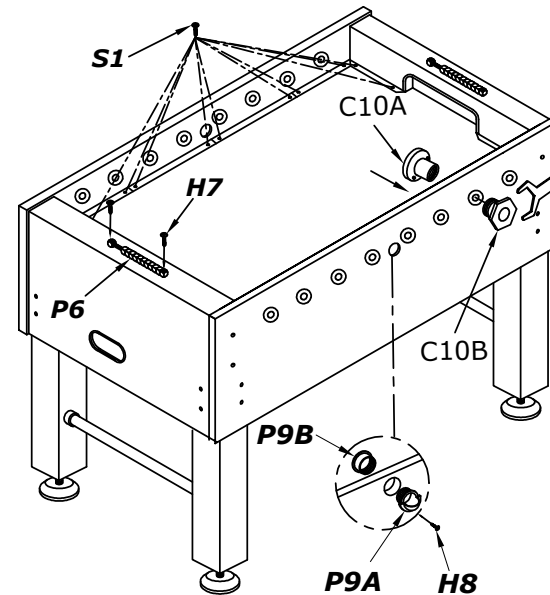
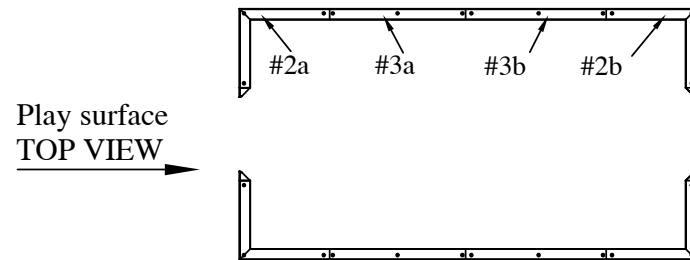

FIGURE 4



ASSEMBLY INSTRUCTIONS

SOCCKER TABLE ASSEMBLY

WARING: TWO ADULTS NEEDED TO ASSEMBLE SOCCER TABLE

5. ATTACH THE FIXED IRON **P12** TO THE LEGS WITH **H2&H3** AS SHOWN IN **figure 3** .
 INSERT CROSS BAR **P13** INTO LEGS AS SHOWN IN **FIGURE 3**. ATTACH THE LEGS **P4A&P4B** WITH BOLTS **H1** AND WASHERS **H2** AS SHOWN IN **figure 3** .
 ATTACH THE CROSS BAR WITH **H6** AS SHOWN IN **figure 3** .
 *TIGHTEN HARDWARE AT THIS TIME!
 ATTACH THE LEG LEVELERS **P10** AS SHOWN IN **figure 3** .

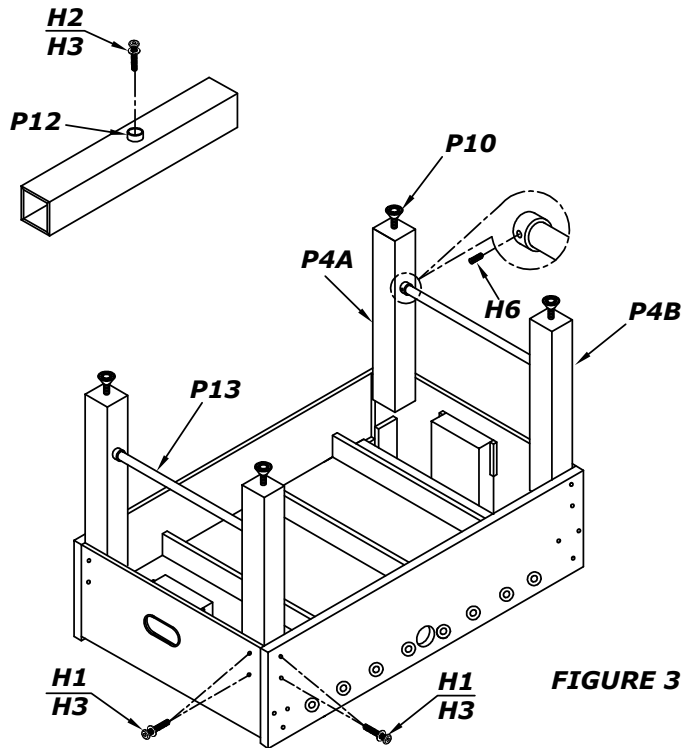
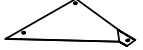

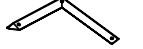
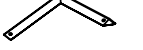



FIGURE 3







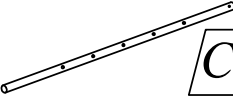
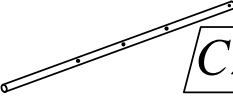
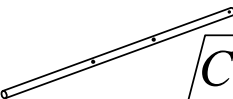

PARTS IDENTIFIER

ASSEMBLY PARTS

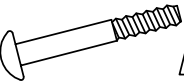
| | | | |
|---|-----|-------------------|---|
|  | #1a | TRIANGLE a | 2 |
|  | #1b | TRIANGLE b | 2 |
|  | #2a | L STYLE PLASTIC a | 2 |
|  | #2b | L STYLE PLASTIC b | 2 |
|  | #3a | LONG PLASTIC a | 2 |
|  | #3b | LONG PLASTIC b | 2 |

PARTS IDENTIFIER

REPLACEMENT PARTS

| | DESCRIPTION | QTY |
|---|-----------------------------------|-----|
|  C1 | 5 PLAYER ROD | 2 |
|  C2 | 3 PLAYER ROD | 4 |
|  C3 | 2 PLAYER ROD | 2 |
|  C4 | RUBBER BUSHING | 16 |
|  C5 | PLASTIC ROD WASHERS | 16 |
|  C6 | 1-1/8" BOLT (used to install men) | 26 |
|  C7 | LOCKING NUT (used to install men) | 26 |
|  C8 | HOME MEN | 13 |
|  C9 | AWAY MEN | 13 |
|  C10A | ROD BUSHING A | 16 |
|  C10B | ROD BUSHING B | 16 |

ASSEMBLY INSTRUCTIONS

SOCCER TABLE ASSEMBLY

WARNING: TWO ADULTS NEEDED TO ASSEMBLE SOCCER TABLE

1. INSERT PLAY FIELD **P3** INTO THE GROOVE ON THE SIDE PANELS **P1** WITH GRAPHICS FACING DOWN. SEE **figure 1**
2. PLACE THE PLAYFIELD SUPPORT BRACES **P5** ON THE BOTTOM OF THE PLAYFIELD. INSERT LONG BOLT **P11** INTO THE HOLE OF THE SIDE PANEL **P1** AND ATTACH IT WITH WASHER **H5**, NUT **H4** AS SHOWN IN **figure 1**. (CAUTION: Do not over-tighten hardware!)

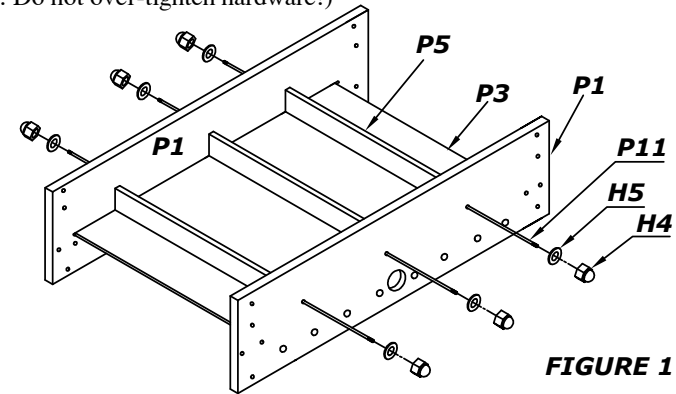

FIGURE 1

3. ATTACH THE TWO END PANELS **P2** TO THE SIDE PANELS **P1** AS SHOWN IN **figure 2**. **REMEMBER: THE GROOVE MUST FACE INWARD TOWARD THE PLAY FIELD.**
4. INSERT THE LONG BOLT **P11** INTO THE HOLE OF THE PANEL AND ATTACH IT WITH WASHER **H5**, NUT **H4** AS SHOWN IN **figure 2**.

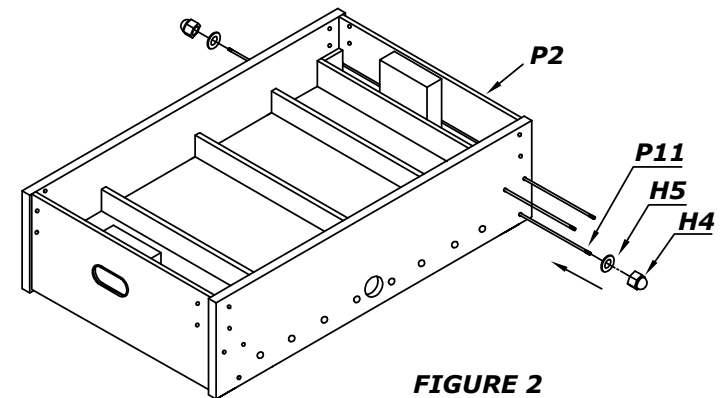

FIGURE 2